



40th EKF Junior&Cadet Karate Champ. 5th Under 21

TURKEY - Konya

8/2/2013 - 10/2/2013

Junior Kumite Female 59+ kg

Entries: 26

HUN231 E.SZABO [0]
RUS412 N.ABRAMENKO [3]
AUT251 A.KORNDON [0]
SLO273 T.VRBNJAK [3]
SCO196 H.WOOD [0]
ITA377 S.SEMERARO [2]
BIH320 I.CAVAR []
<BYE>
GRE419 A.DELLI [6]
ENG297 J.POMEROY [5]
NOR173 L.ANDERSEN []
<BYE>
LAT209 V.RAZAJEVA [1]
CRO321 A.SKUNCA [0]
MNE251 S.DJURIC []
<BYE>
UKR293 O.RYABOVA [1]
SVK340 S.ORIABINCOVA [3]
IRL149 N.PERRY [1]
SRB422 N.NIKLIC [2]
FYR315 I.ATANASOVA [0]
LUX141 P.GIORGETTI [4]
SWE184 L.RASMUSSEN []
<BYE>
BUL254 E.RIZOVA [0]
TUR370 N.CICEK [5]
NED247 E.WALTZ []
<BYE>
GER510 K.KEMMET [2]
DEN173 K.PEDERSEN [0]
FRA372 N.GARCIA []
<BYE>

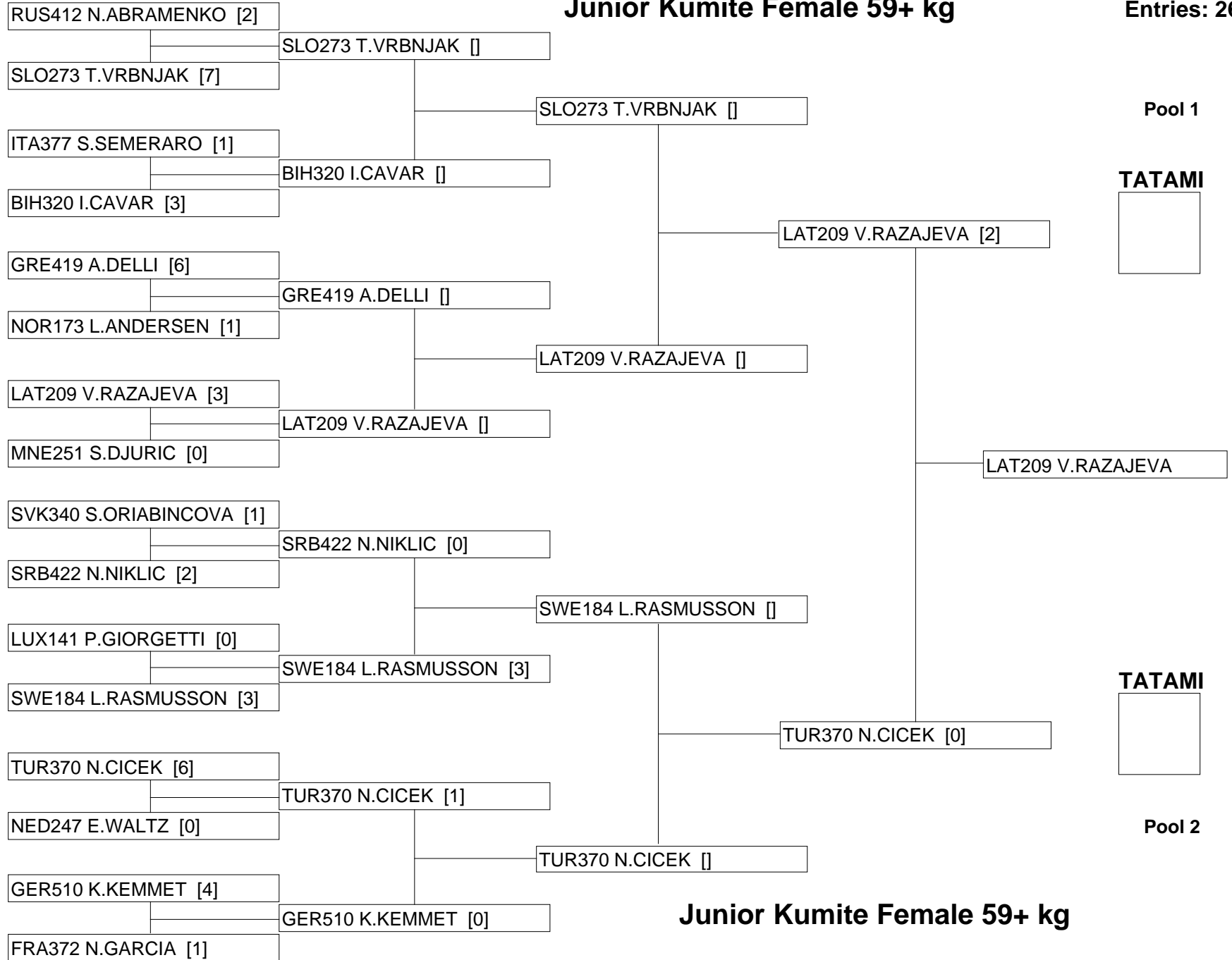



40th EKF Junior&Cadet Karate Champ. 5th Under 21

TURKEY - Konya

8/2/2013 - 10/2/2013

Junior Kumite Female 59+ kg

Repechage Pool 1

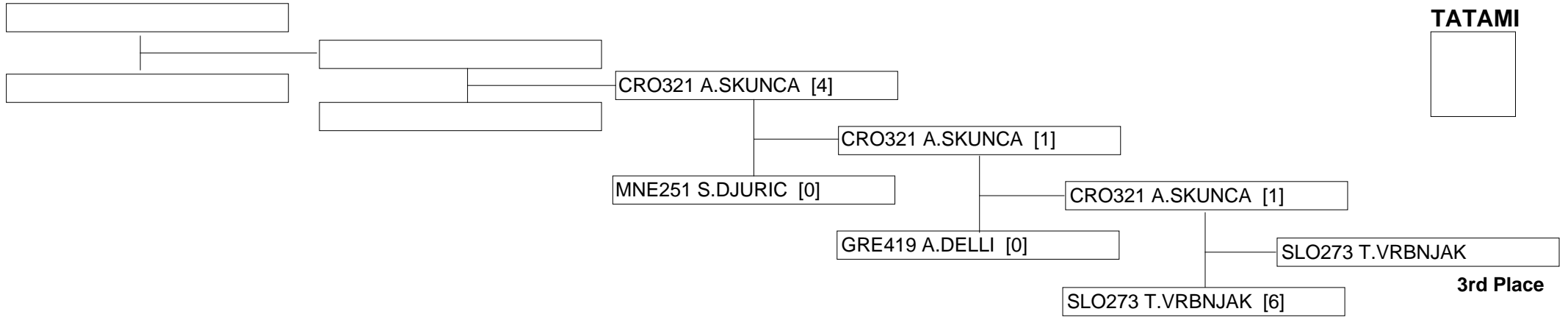

Repechage Pool 2

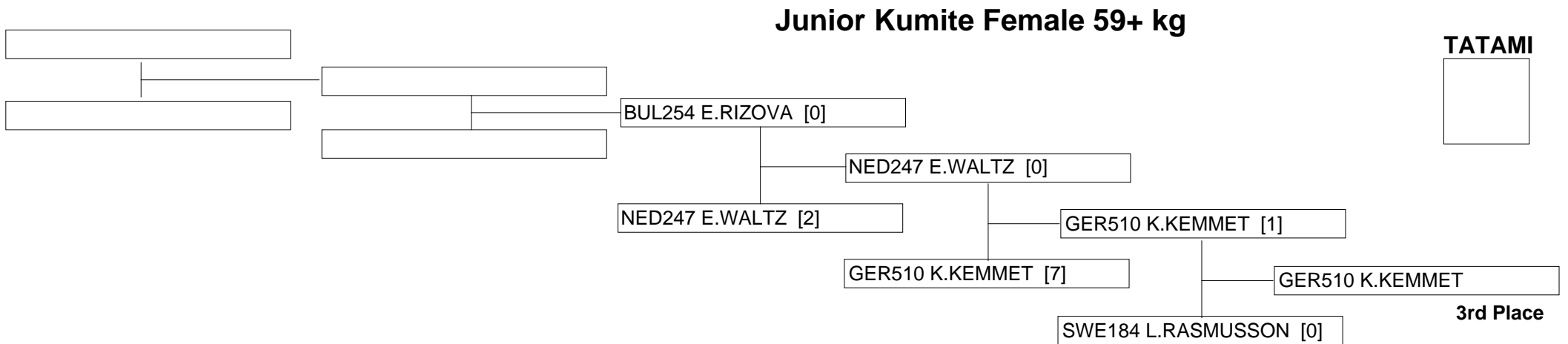



40th EKF Junior&Cadet Karate Champ. 5th Under 21

TURKEY - Konya

8/2/2013 - 10/2/2013

Junior Kumite Female -48 kg

Entries: 22

MNE207 D.MILJANIC [5]
FIN195 R.KIVINIEMI [1]
ISR156 C.AMOS []
<BYE>
HUN210 L.VAJDA [4]
SRB423 D.NEGOVANOVIC [8]
BIH449 M.DELIC []
<BYE>
SLO238 D.CATAKOVIC [4]
SVK335 V.KADLECIKOVA [1]
GRE404 D.KARIPIDOU []
<BYE>
ITA376 E.PERFETTO []
<BYE>
GER505 L.NEUMANN []
<BYE>
ESP445 G.MORALES [3]
CYR183 S.ZENIOS [0]
TUR552 S.AKKURT []
<BYE>
FRA330 S.BOUDERBANE [2]
NED210 Y.KUYPER [0]
RUS631 M.BOROZDINA []
<BYE>
POR221 J.ALMEIDA [0]
ENG301 L.TUTTY [3]
FYR459 A.TOSHEVSKA []
<BYE>
CRO357 M.BERULEC []
<BYE>
SUI248 F.WABER []
<BYE>





40th EKF Junior&Cadet Karate Champ. 5th Under 21

TURKEY - Konya

8/2/2013 - 10/2/2013

Junior Kumite Female -48 kg

Repechage Pool 1

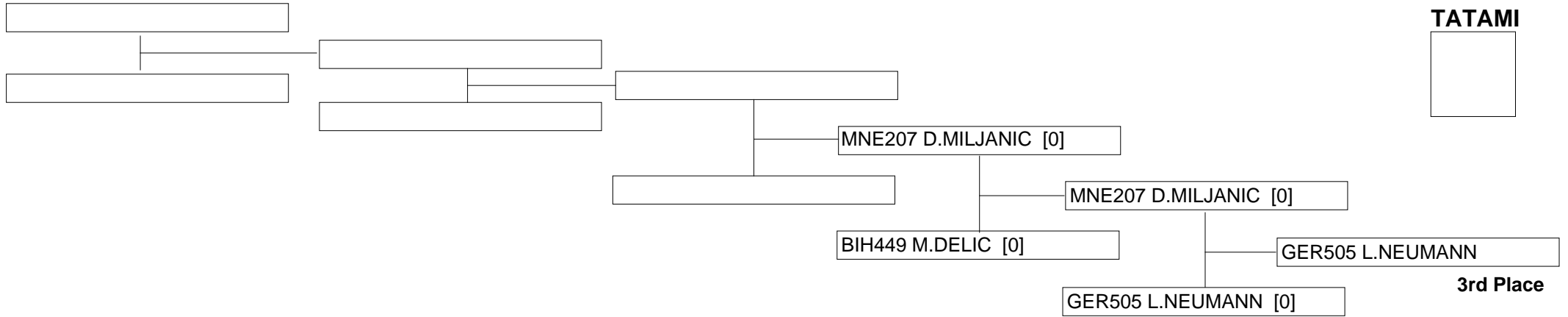

Repechage Pool 2

Junior Kumite Female -48 kg

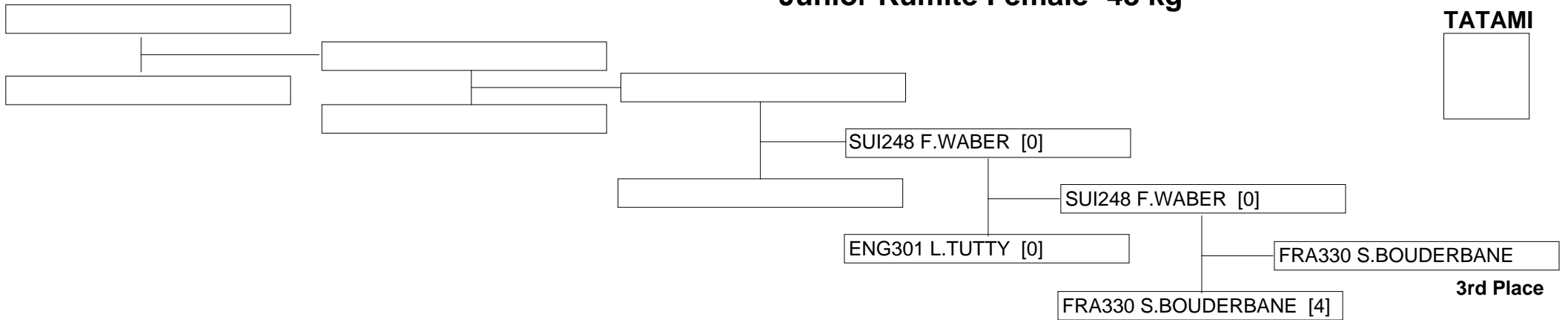



40th EKF Junior&Cadet Karate Champ. 5th Under 21

TURKEY - Konya

8/2/2013 - 10/2/2013

Junior Kumite Female -59 kg

Repechage Pool 1

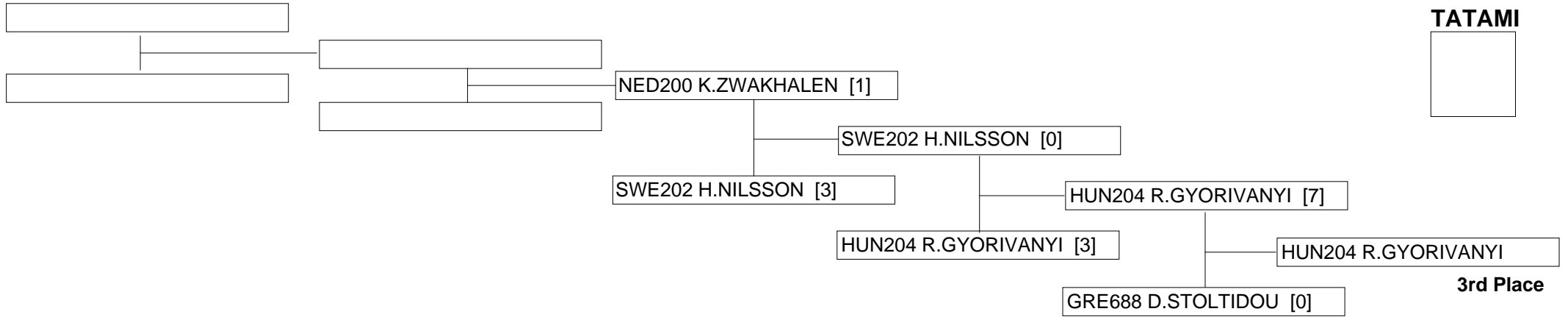

Repechage Pool 2

Junior Kumite Female -59 kg

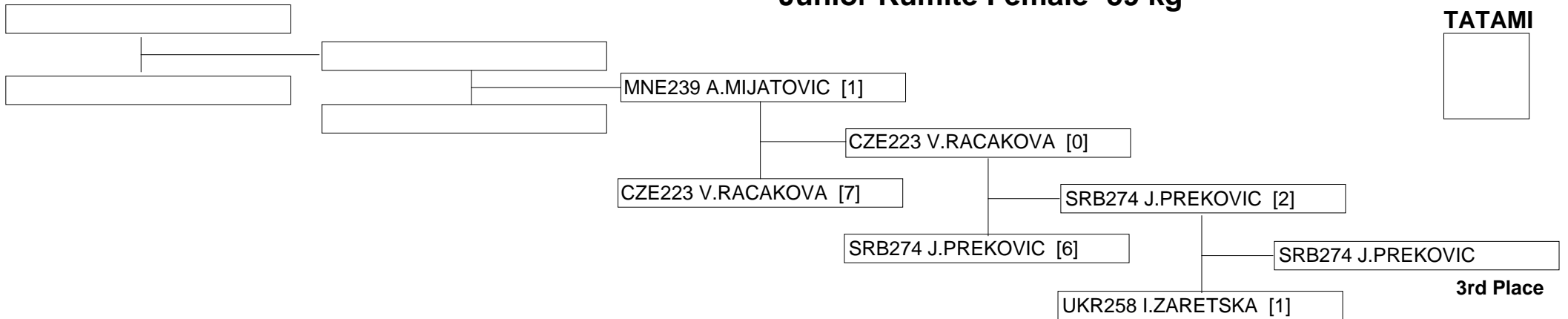



40th EKF Junior&Cadet Karate Champ. 5th Under 21

TURKEY - Konya

8/2/2013 - 10/2/2013

Junior Kata Female

Entries: 26

- CRO365 N.JUKIC [Gsh/Sho]
- SUI214 V.WILL [Enpi]
- ESP434 M.MORATA [Unshu]
- BLR212 M.FURSAVA [Annan]
- FIN199 L.TAMMINEN [Gsh/Sho]
- FRA326 P.BOUCHEM [Enpi]
- ITA308 T.D ONOFRIO []
- <BYE>
- GRE318 E.BYROU [Gsh/Sho]
- RUS508 I.TROITSKAYA [Kank]
- SVK317 A.OVECKOVA []
- <BYE>
- GER387 S.GRAF [Kank Sho]
- DEN181 R.LINCK [Chat Kus]
- SLO239 A.HLADNIK []
- <BYE>
- LAT216 L.AGAFONOVA [Unsu]
- FYR263 N.GJORGJEVIK [Kank]
- HUN214 L.STERCK [Paiku]
- CZE258 T.ZLATOHLAVKOVA []
- SWE182 E.ERNEKRANS [Nipa]
- ENG285 A.SELL [Nipaipo]
- TUR346 R.KUSMUS []
- <BYE>
- POR187 M.SANTOS [Annan]
- SRB260 B.MLADEZIC [Kank S]
- AUT223 J.RATH []
- <BYE>
- SCO216 S.WILSON [Enpi]
- UKR270 A.KRESHCHENKO [K]
- LUX133 O.DA COSTA []
- <BYE>

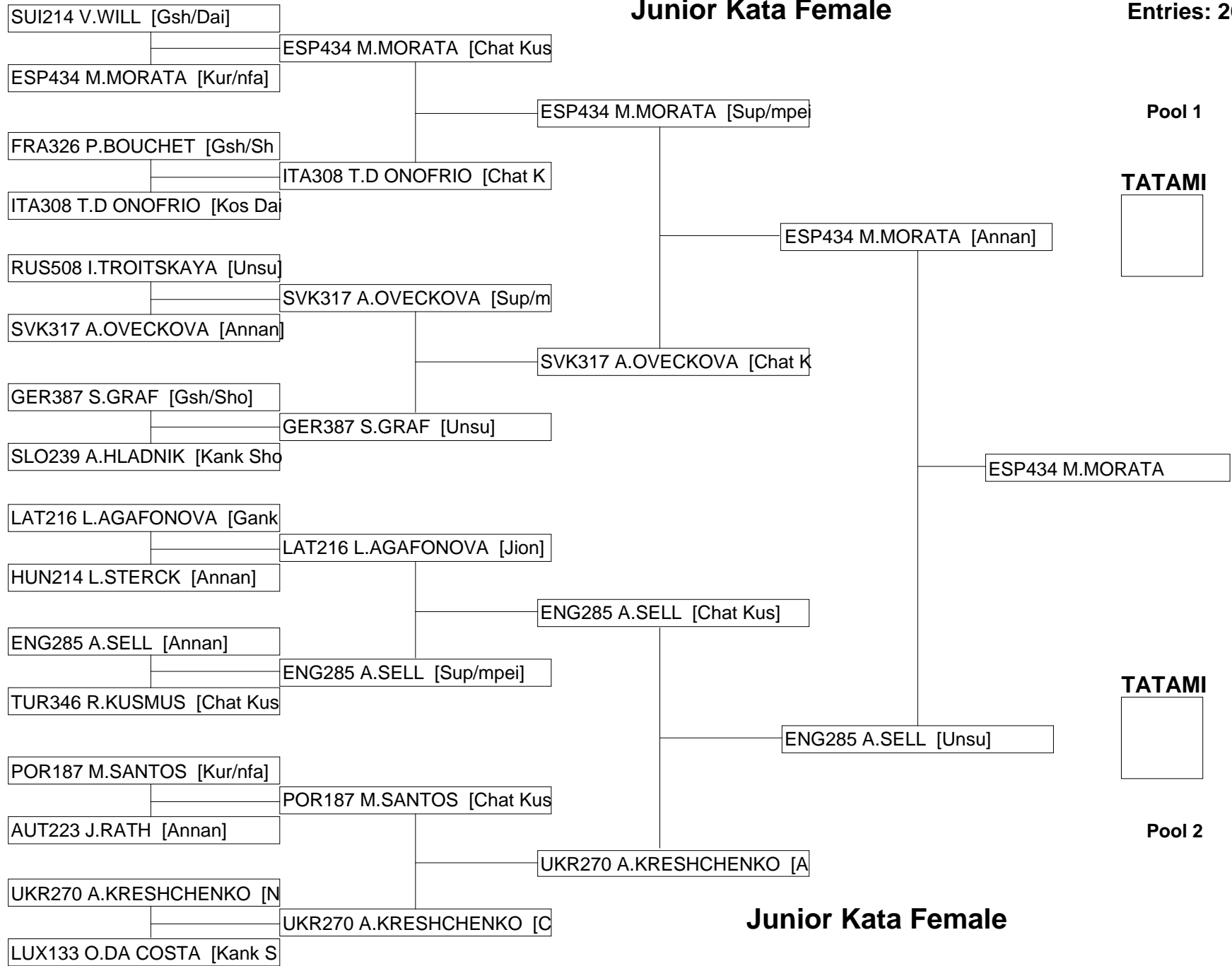

Junior Kata Female



40th EKF Junior&Cadet Karate Champ. 5th Under 21

TURKEY - Konya

8/2/2013 - 10/2/2013

Junior Kata Female

Repechage Pool 1

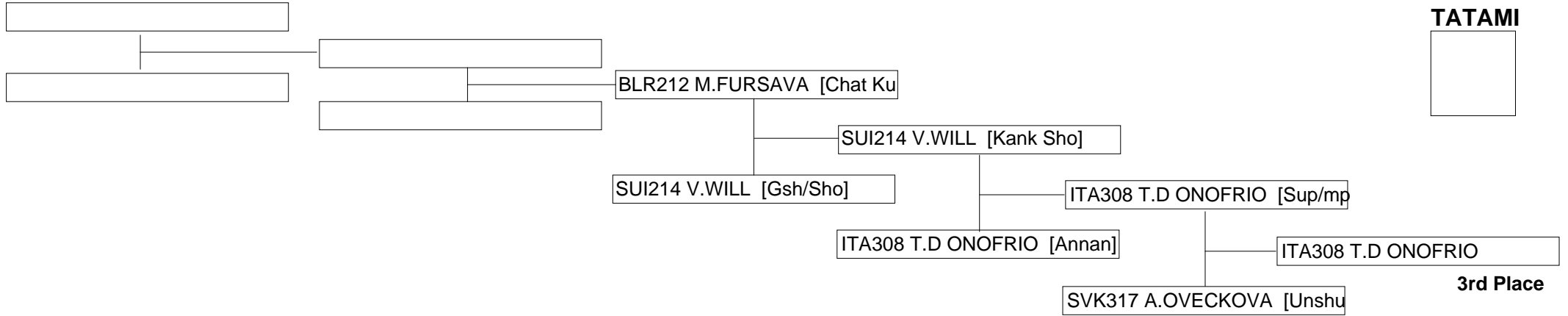

Repechage Pool 2

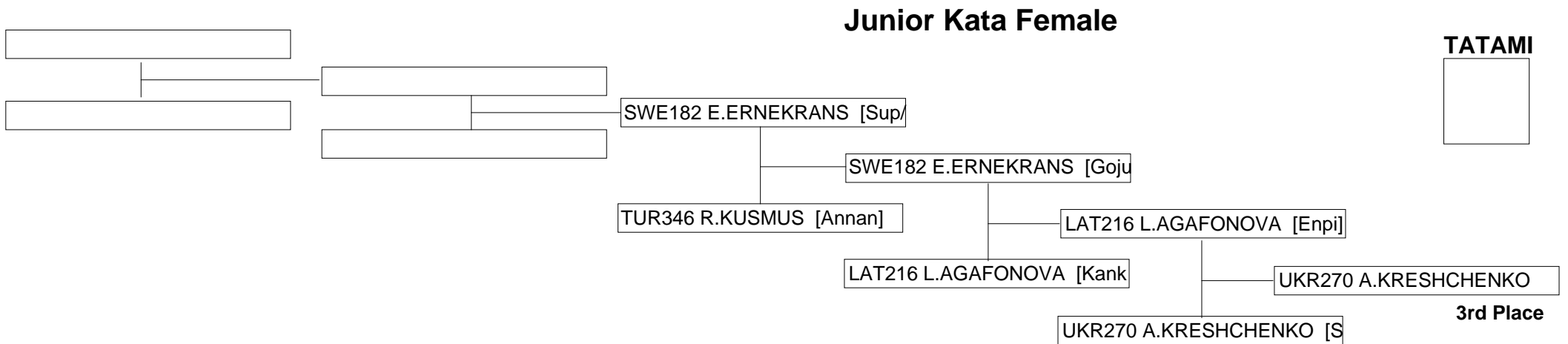



40th EKF Junior&Cadet Karate Champ. 5th Under 21

TURKEY - Konya

8/2/2013 - 10/2/2013

Junior Kata Male

Entries: 28

- SLO245 A.KLANECEK [Kank D
- HUN216 M.GRECZI [Heiku]
- POR244 A.SANTOS [Gsh/Sho]
- SWE203 L.ORTERSTROM [Ch
- ESP513 A.GARCIA VARGAS [
- DEN182 A.EKKERT [Annan]
- GER359 M.SCHINKE []
- <BYE>
- BIH316 N.TOPIC [Kank Dai]
- CYR193 C.NICOLAOU [Sup/m
- GRE362 A.POLICHRONOS [K
- TUR353 A.SOFUOGLU [Enpi]
- ITA505 S.STEA [Gsh/Sho]
- SRB426 D.SRDJEVIC [Unsu]
- AZE246 R.ALIYEV []
- <BYE>
- LUX140 E.PEREIRA HENRIQU
- FRA534 K.NGOAN [Enpi]
- CRO334 M.MORZAN [Gsh/Sho
- BEL194 P.TRESEGNIE [Kank
- ISR146 S.RAFAILOV [Sochin]
- FYR273 V.BESLIEV [Gsh/Sho]
- ENG317 N.PATEL []
- <BYE>
- SCO206 J.SZAFRANEK [Sup/
- CZE230 D.WOJTYLA [Gsh/Dai]
- SVK299 J.BORECKY [Chat Ku
- RUS392 M.KSENOFONTOV [G
- FIN181 R.SALMI [Unsu]
- AUT258 D.SZABO [Kank Sho]
- MNE258 D.VUKOTIC []
- <BYE>

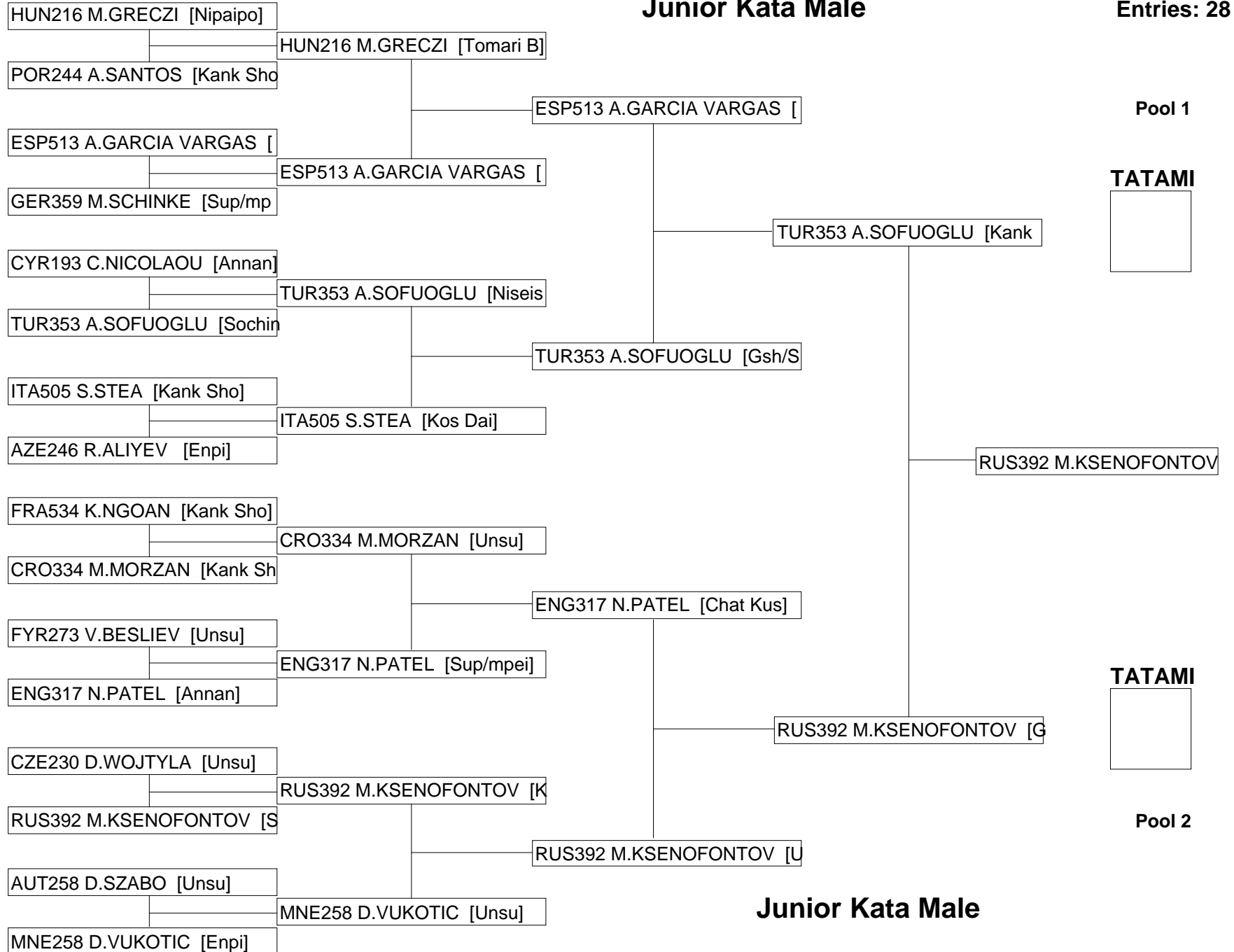



40th EKF Junior&Cadet Karate Champ. 5th Under 21

TURKEY - Konya

8/2/2013 - 10/2/2013

Junior Kumite Male 76+ kg

TATAMI



TUR520 M.YILDIZ [3]

TUR520 M.YILDIZ

DEN176 C.PEDERSEN [0]

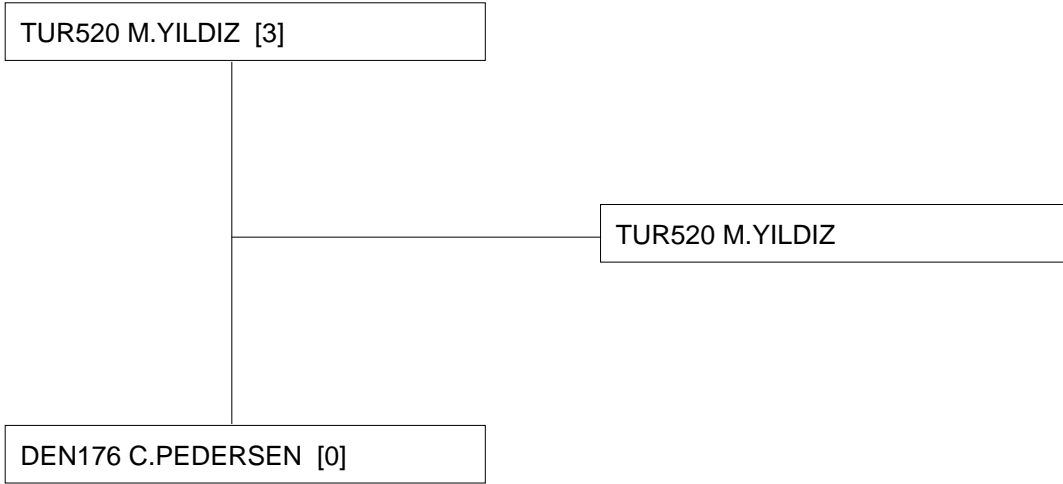



40th EKF Junior&Cadet Karate Champ. 5th Under 21

TURKEY - Konya

8/2/2013 - 10/2/2013

Entries: 33

Junior Kumite Male 76+ kg

Pool 1

TATAMI

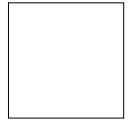

TATAMI

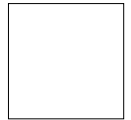

POR222 H.RAMOS [2]
FYR335 E.RISTEVSKI [1]
ISR158 A.BERCOVICH []
<BYE>
BIH264 B.MEHOVIC []
<BYE>
MNE262 M.PETRIC []
<BYE>
ITA379 P.LONGBARDI []
<BYE>
AZE253 S.GULUZADE []
<BYE>
GRE523 N.VAVOULIDIS []
<BYE>
ROM269 C.MIHALACHE []
<BYE>
CRO367 A.KVESIC []
<BYE>
ARM148 G.KALASHYAN []
<BYE>
CYR320 E.NICOLAOU []
<BYE>
SRB308 N.PLANIC []
<BYE>
FIN184 P.HEISKANEN []
<BYE>
NOR175 J.MALINVERNO []
<BYE>
LAT222 R.KORNISOVS []
<BYE>
TUR520 M.YILDIZ []
<BYE>



Junior Kumite Male 76+ kg



40th EKF Junior&Cadet Karate Champ. 5th Under 21

TURKEY - Konya

8/2/2013 - 10/2/2013

Junior Kumite Male 76+ kg

Entries: 33

AUT258 D.SZABO []
<BYE>
BLR226 A.ISAKAU []
<BYE>
UKR299 T.HERCHUK []
<BYE>
SLO257 P.SUMANDL []
<BYE>
GER361 B.KERBER []
<BYE>
SVK302 I.KABASHI []
<BYE>
DEN176 C.PEDERSEN []
<BYE>
SWE199 O.DACKLAND []
<BYE>
ESP557 D.ARANA []
<BYE>
RUS438 A.SAMARINOV []
<BYE>
GEO170 G.KARELI []
<BYE>
ENG302 J.OTTO []
<BYE>
BEL192 S.ADAMS []
<BYE>
CZE249 O.ANDORFER []
<BYE>
HUN242 C.FOLDESI []
<BYE>
EST191 T.PAABO []
<BYE>



Pool 2

TATAMI

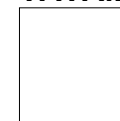

TATAMI

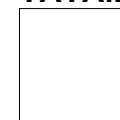

Junior Kumite Male 76+ kg



40th EKF Junior&Cadet Karate Champ. 5th Under 21

TURKEY - Konya

8/2/2013 - 10/2/2013

Entries: 27

Junior Kumite Male -55 kg

BIH326 I.KRIZANAC [5]
RUS473 S.OGANIAN [0]
FRA531 K.TAVARES LOPES []
ENG316 C.HOLMES [1]
FIN197 M.MAKKONEN [0]
IRL135 A.MCLOUGHLIN [5]
TUR743 G.FILIZ []
<BYE>
POR246 J.XAVIER [2]
SWE206 A.TAFARI [3]
FYR383 M.GJURCHINOVSKI []
HUN257 T.DERZSI [3]
GRE429 M.RELIAS [1]
AZE272 J.SAFARLI [4]
UKR313 D.KORNIYCHUK []
<BYE>
BLR239 V.PAPRUHA [4]
ISR169 R.VERSOLKER [3]
SLO277 D.GORENC [1]
ITA511 L.BISACCIA [7]
GER418 V.FUCHS [4]
SRB307 D.AHMETOVIC [0]
ROM270 V.RADU []
<BYE>
CYR192 I.KYROY [0]
SUI250 G.DELETROZ [3]
MNE233 A.MARKASHEVIQ []
<BYE>
CRO343 B.BERAK [1]
SVK318 R.STYRIAK [0]
BEL222 I.BELLARAJ []
<BYE>



Junior Kumite Male -55 kg



40th EKF Junior&Cadet Karate Champ. 5th Under 21

TURKEY - Konya

8/2/2013 - 10/2/2013

Junior Kumite Male -55 kg

Repechage Pool 1

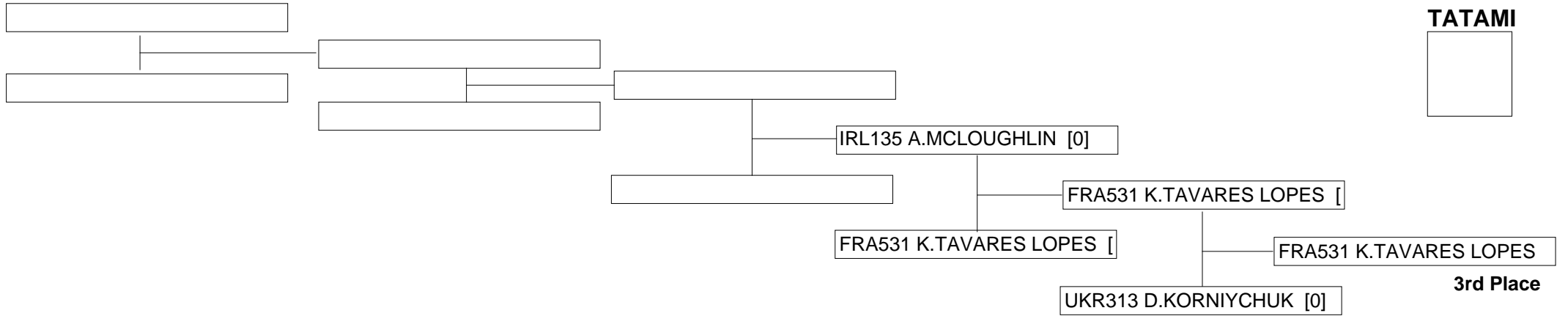

Repechage Pool 2

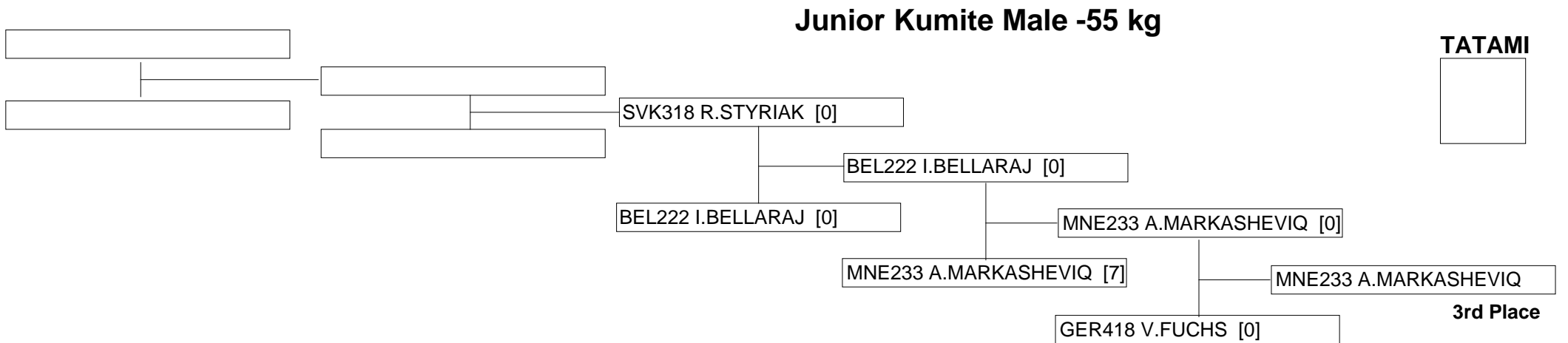



40th EKF Junior&Cadet Karate Champ. 5th Under 21

TURKEY - Konya

8/2/2013 - 10/2/2013

Junior Kumite Male -61 kg

TATAMI

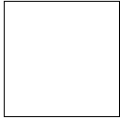

FRA412 S.DACOSTA [5]

FRA412 S.DACOSTA

DEN192 C.NOERSKOV-JENSEN [0]

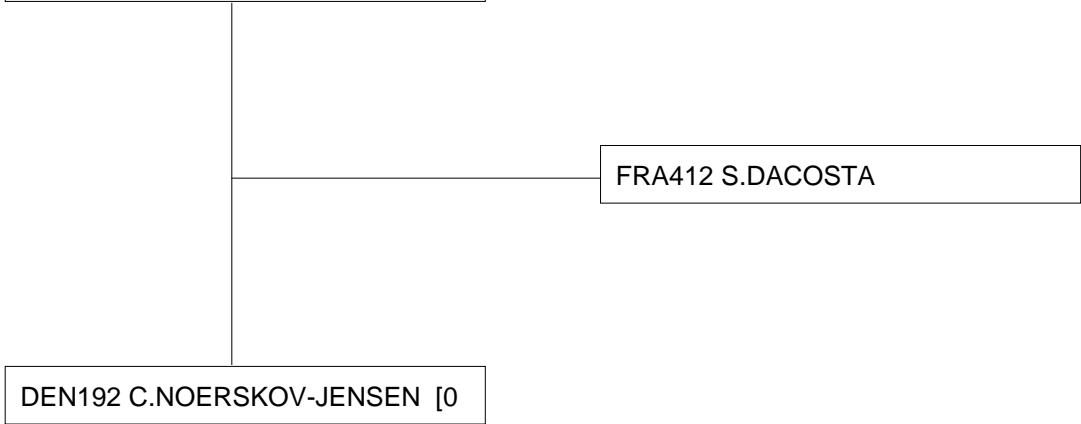



40th EKF Junior&Cadet Karate Champ. 5th Under 21

TURKEY - Konya

8/2/2013 - 10/2/2013

BIH314 E.GALIC [7]
ISR159 O.CANDITAN [0]
SRB419 A.LEKIC []
<BYE>
LUX136 J.VAN SCHIL []
<BYE>
LAT223 .KOSTILEVS []
<BYE>
FYR299 M.STOJMENOV []
<BYE>
FIN196 T.LINDHOLM []
<BYE>
SUI268 B.SCHMIDLIN []
<BYE>
NED213 E.VAN KLEEF []
<BYE>
ITA335 V.ACERBO []
<BYE>
HUN256 P.VIRGA []
<BYE>
TUR749 F.MERCAN []
<BYE>
UKR321 R.ZHYVKO []
<BYE>
IRL150 J.REILLY []
<BYE>
BUL260 A.DIMITROV []
<BYE>
RUS435 I.PONOMAREV []
<BYE>
FRA412 S.DACOSTA []
<BYE>



Junior Kumite Male -61 kg

Entries: 33

Pool 1

TATAMI



TATAMI

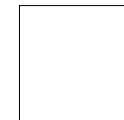

Junior Kumite Male -61 kg



40th EKF Junior&Cadet Karate Champ. 5th Under 21

TURKEY - Konya

8/2/2013 - 10/2/2013

Junior Kumite Male -61 kg

Entries: 33

Pool 2

TATAMI

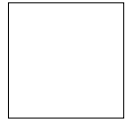

TATAMI

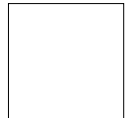

BLR229 A.NIARUBENKA []
<BYE>
AUT234 L.RETTENBACHER []
<BYE>
AZE260 N.ABBASOV []
<BYE>
SLO270 N.BERTONCELJ []
<BYE>
SVK333 J.HUDEC []
<BYE>
CRO373 R.SGARDELLI []
<BYE>
POR248 R.GAVINHO []
<BYE>
EST185 R.VALIJEV []
<BYE>
ARM152 K.ANDRESYAN []
<BYE>
NOR159 B.HJERPAASEN []
<BYE>
ROM267 B.GOGOLOSI []
<BYE>
CZE246 J.KOUDELKA []
<BYE>
GRE506 D.MITAKOS []
<BYE>
DEN192 C.NOERSKOV-JENSE
<BYE>
ENG282 J.KIERNAN []
<BYE>
SCO208 A.EL SHAFEI []
<BYE>



Junior Kumite Male -61 kg



40th EKF Junior&Cadet Karate Champ. 5th Under 21

TURKEY - Konya

8/2/2013 - 10/2/2013

Junior Kumite Male -61 kg

Repechage Pool 1

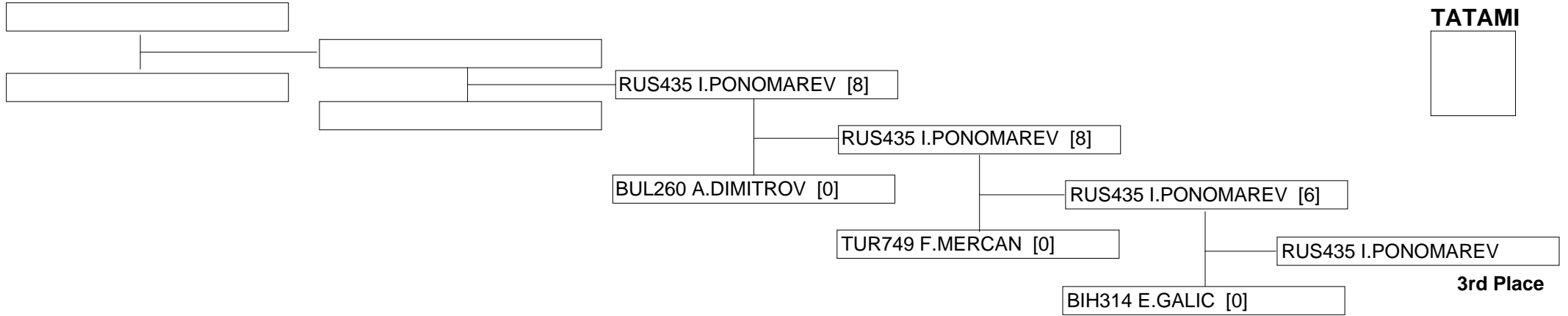

Repechage Pool 2

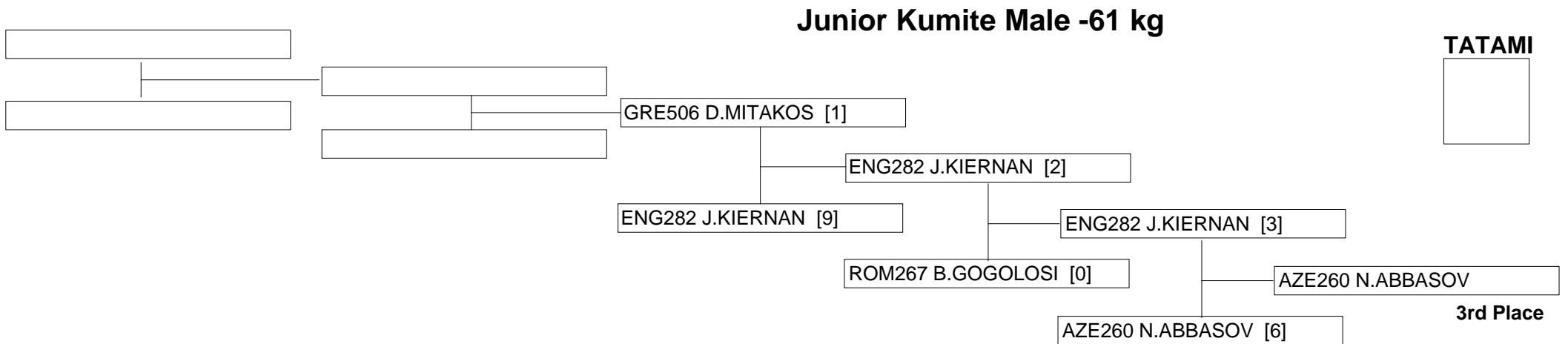



40th EKF Junior&Cadet Karate Champ. 5th Under 21

TURKEY - Konya

8/2/2013 - 10/2/2013

Junior Kumite Male -68 kg

TATAMI



BIH447 A.BRICA [0]

TUR492 B.UYGUR

TUR492 B.UYGUR [1]

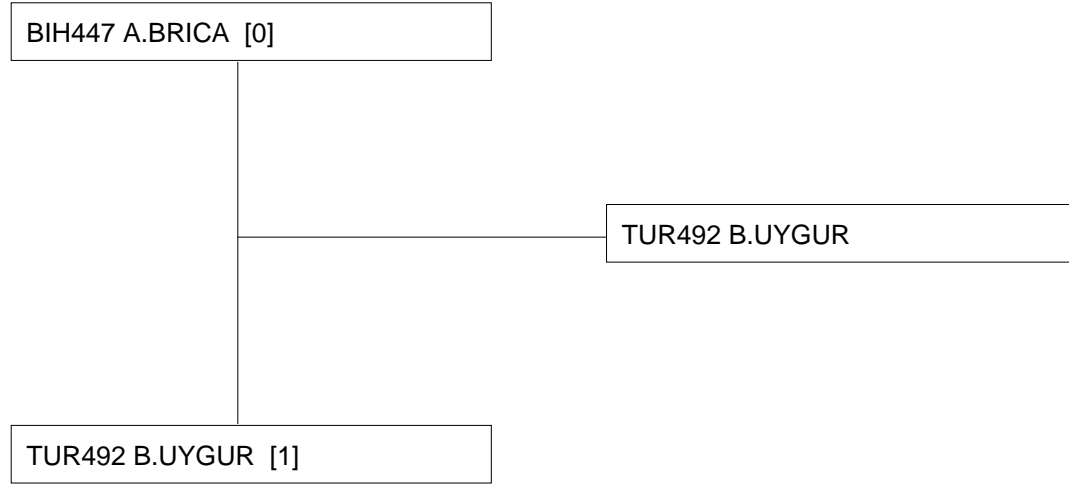



40th EKF Junior&Cadet Karate Champ. 5th Under 21

TURKEY - Konya

8/2/2013 - 10/2/2013

Junior Kumite Male -68 kg

Entries: 36

ESP515 R.CUERVA MORA [8]
SCO209 J.BRADLEY [0]
<BYE>
GEO174 N.CHKHAIDZE []
<BYE>
HUN203 N.SZILVA []
<BYE>
NED205 N.GERRESE []
<BYE>
SUI213 R.WEIBEL []
<BYE>
ARM143 S.SARGSYAN []
<BYE>
GER357 F.BEHRENDT []
<BYE>
FRA532 C.SEGUY []
<BYE>
BIH447 A.BRICA [1]
POR252 G.MARTA [0]
ISR154 D.AFSANOV []
<BYE>
BEL191 J.CUSTINNE []
<BYE>
SWE204 E.SABIC []
<BYE>
LUX143 S.DA FONTE []
<BYE>
MNE370 A.PALAMAR []
<BYE>
AUT247 R.RETTENBACHER []
<BYE>
EST198 I.TSIBISOV []
<BYE>



Pool 1

TATAMI

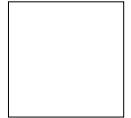

TATAMI

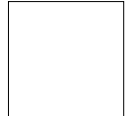

Junior Kumite Male -68 kg



40th EKF Junior&Cadet Karate Champ. 5th Under 21

TURKEY - Konya

8/2/2013 - 10/2/2013

ITA307 F.D ONOFRIO [3]
FYR342 A.ISMAIL [0]
RUS452 N.RODIONOV []
<BYE>
AZE269 S.GULUZADE []
<BYE>
GRE307 D.XENOS []
<BYE>
BLR222 I.KIRZNER []
<BYE>
UKR310 S.DROZD []
<BYE>
SLO255 T.OTRIN []
<BYE>
CRO332 I.MARTINAC []
<BYE>
DEN162 T.PEDERSEN [3]
BUL221 E.SERBEST [1]
IRL145 J.HARRIGAN []
<BYE>
ENG314 J.KELLAWAY []
<BYE>
SVK296 M.HOMOLA []
<BYE>
CYR189 S.SALATAS []
<BYE>
TUR492 B.UYGUR []
<BYE>
FIN200 A.TUOMINEN []
<BYE>
SRB425 S.NESKOVIC []
<BYE>

ITA307 F.D ONOFRIO [0]
ITA307 F.D ONOFRIO [0]
RUS452 N.RODIONOV [0]
AZE269 S.GULUZADE [1]
GRE307 D.XENOS [8]
GRE307 D.XENOS [5]
BLR222 I.KIRZNER [0]
UKR310 S.DROZD [4]
UKR310 S.DROZD [1]
SLO255 T.OTRIN [1]
CRO332 I.MARTINAC [0]
CRO332 I.MARTINAC [3]
DEN162 T.PEDERSEN [2]
DEN162 T.PEDERSEN [3]
IRL145 J.HARRIGAN [0]
ENG314 J.KELLAWAY [8]
ENG314 J.KELLAWAY [1]
SVK296 M.HOMOLA [0]
CYR189 S.SALATAS [0]
TUR492 B.UYGUR [2]
TUR492 B.UYGUR [8]
FIN200 A.TUOMINEN [2]
FIN200 A.TUOMINEN [0]
SRB425 S.NESKOVIC [0]

ITA307 F.D ONOFRIO [0]
GRE307 D.XENOS [3]
GRE307 D.XENOS [8]
GRE307 D.XENOS [1]
UKR310 S.DROZD [2]
CRO332 I.MARTINAC [0]
DEN162 T.PEDERSEN [0]
ENG314 J.KELLAWAY [1]
TUR492 B.UYGUR [6]
TUR492 B.UYGUR [1]

Junior Kumite Male -68 kg

Entries: 36

Pool 2

TATAMI

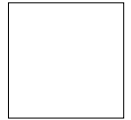

TATAMI

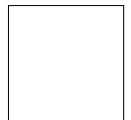

Junior Kumite Male -68 kg



40th EKF Junior&Cadet Karate Champ. 5th Under 21

TURKEY - Konya

8/2/2013 - 10/2/2013

Junior Kumite Male -68 kg

Repechage Pool 1

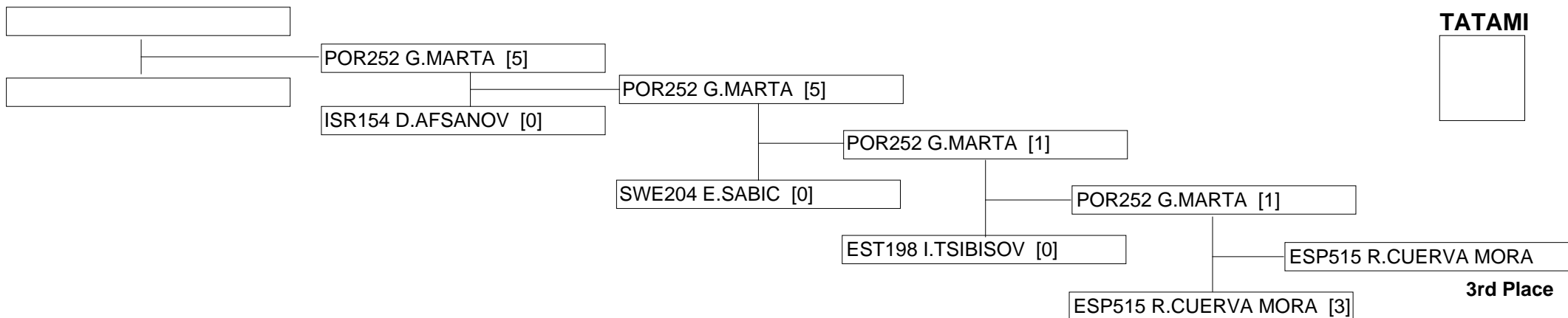

Repechage Pool 2

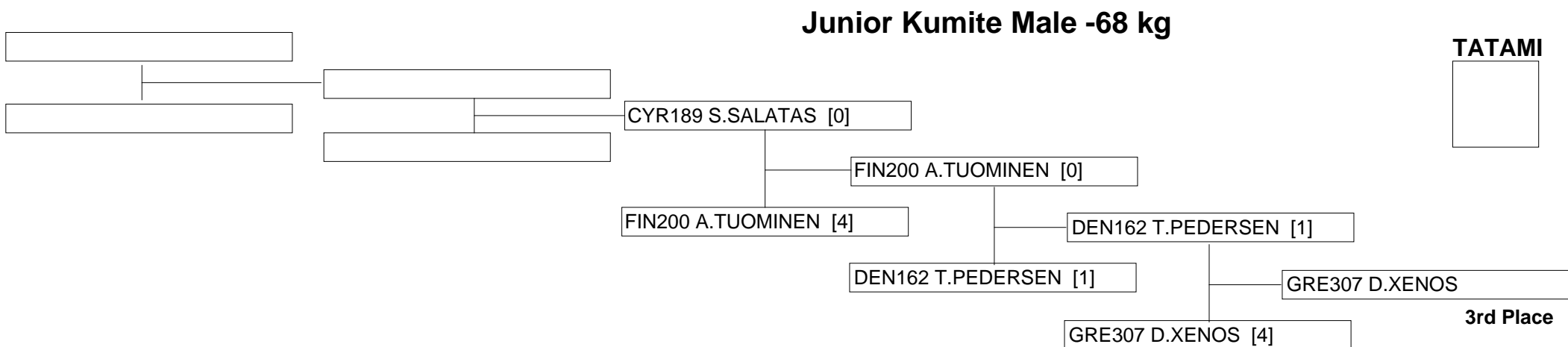



40th EKF Junior&Cadet Karate Champ. 5th Under 21

TURKEY - Konya

8/2/2013 - 10/2/2013

Junior Kumite Male -76 kg

Entries: 28

GEO173 N.KOBALIA [2]
CRO374 V.LONCAR [1]
FRA367 M.LECLAIRE [0]
MNE263 V.KOPITOVIC [1]
HUN258 G.HARSPATAKI [3]
UKR301 R.KMIT [0]
SLO234 F.SPANBAUER []
<BYE>
GER369 L.SIEBEL [0]
DEN188 K.KORTE [3]
FYR270 V.KRSTEVSKI [4]
BUL339 R.VACHEV [1]
CYR287 T.LOIZIDES [0]
POR182 T.SENRA [3]
ROM266 N.DANCILA []
<BYE>
RUS459 A.GANZEN [7]
ITA514 M.HASANI [0]
AZE242 M.HASANLI [0]
LAT212 J.KOROLKOVS [8]
BIH446 A.ALIVUK [2]
SVK321 M.DZACOVSKY [4]
SWE198 V.BULL []
<BYE>
GRE272 T.KALOGIANNIS [2]
TUR331 U.AKTAS [3]
NOR161 A.SLETTEVOLD [2]
ENG318 A.TAYLOR [1]
LUX140 E.PEREIRA HENRIQU
SRB273 B.MISOVIC [0]
ISR166 E.SHAPIRA []
<BYE>

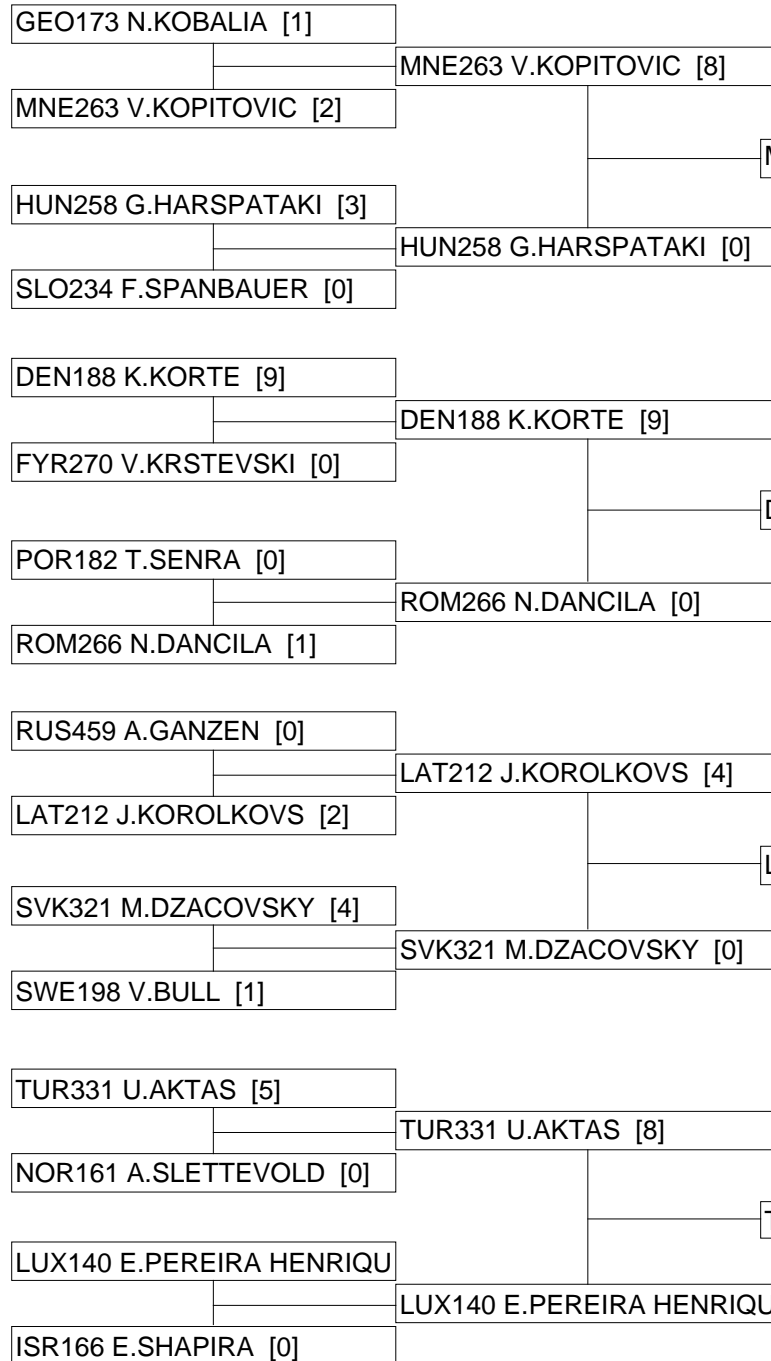

Pool 1

TATAMI

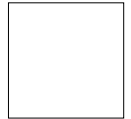

TATAMI

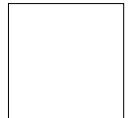

Pool 2

Junior Kumite Male -76 kg



40th EKF Junior&Cadet Karate Champ. 5th Under 21

TURKEY - Konya

8/2/2013 - 10/2/2013

Junior Kumite Male -76 kg

Repechage Pool 1

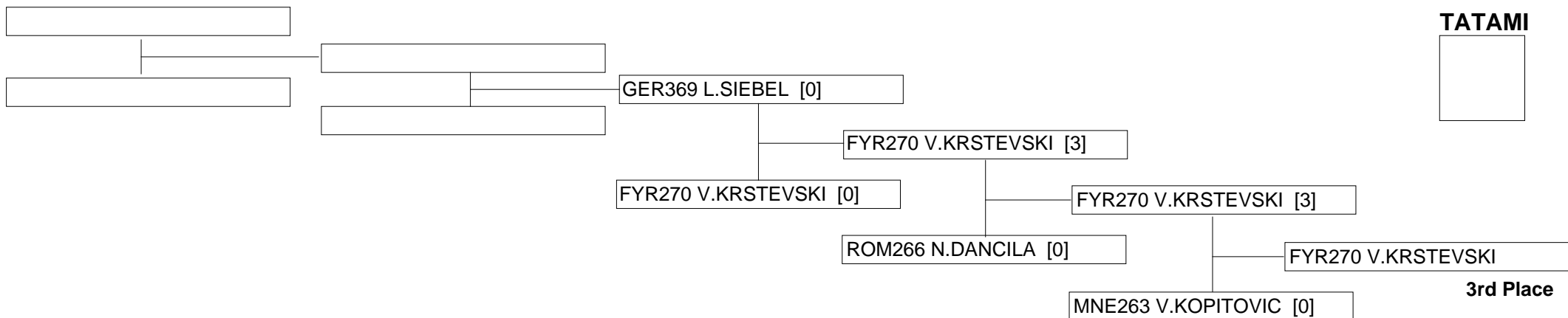

Repechage Pool 2

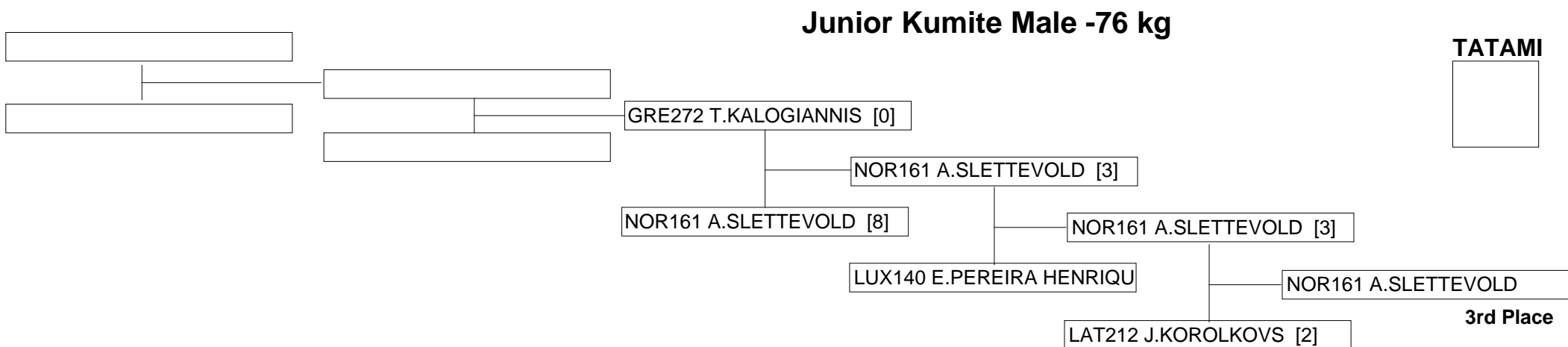



40th EKF Junior&Cadet Karate Champ. 5th Under 21

TURKEY - Konya

8/2/2013 - 10/2/2013

Under 21 Kata Male

Entries: 25

BEL184 Y.RODRIGUEZ MERIN
CRO289 A.HAURDIC [Gsh/Sho]
SUI261 F.ASTORINA [Enpi]
DEN146 C.ROHDE [Kur/nfa]
FRA410 E.MONTARELLO [Gsh]
SVK305 P.FABIAN [Chat Kus]
RUS344 E.SKOVORODNIKOV
<BYE>
SRB199 S.CHEMLAL [Gsh/Dai]
FYR445 D.PETKOSKI [Chat Ku]
HUN196 B.NAGY []
<BYE>
AZE206 T.BALJANLI [Enpi]
POR233 L.SILVA [Kank Dai]
TUR314 M.YAKAN []
<BYE>
BUL338 R.BOBEV [Enpi]
CZE203 K.IMRISEK [Chat Kus]
AUT193 C.ERLENWEIN []
<BYE>
LUX123 I.POCERVINA [Enpi]
WAL150 R.ADEY [Enpi]
SLO217 K.PLAZAR []
<BYE>
ITA322 M.BUSATO [Gsh/Sho]
ENG279 A.GARDNER [Kank S]
GER298 P.BAUM []
<BYE>
GRE242 P.KLEVAR [Annan]
SWE175 S.BIRANVAND [Kank]
NED212 F.DE BOER []
<BYE>

BEL184 Y.RODRIGUEZ MERIN
DEN146 C.ROHDE [Chat Kus]
DEN146 C.ROHDE [Annan]
SVK305 P.FABIAN [Annan]
SVK305 P.FABIAN [Sup/mpei]
RUS344 E.SKOVORODNIKOV
SRB199 S.CHEMLAL [Kank Sh]
SRB199 S.CHEMLAL [Enpi]
HUN196 B.NAGY [Annan]
AZE206 T.BALJANLI [Gsh/Dai]
TUR314 M.YAKAN [Kank Sho]
TUR314 M.YAKAN [Nfchn Sa]
CZE203 K.IMRISEK [Sup/mpei]
AUT193 C.ERLENWEIN [Kank]
AUT193 C.ERLENWEIN [Gsh/]
LUX123 I.POCERVINA [Unsu]
SLO217 K.PLAZAR [Unsu]
SLO217 K.PLAZAR [Kank Sho]
ITA322 M.BUSATO [Kank Sho]
ITA322 M.BUSATO [Gsh/Dai]
GER298 P.BAUM [Gsh/Sho]
GRE242 P.KLEVAR [Unsu]
GRE242 P.KLEVAR [Chat Kus]
NED212 F.DE BOER [Kank Sh]

DEN146 C.ROHDE [Sup/mpei]
SVK305 P.FABIAN [Sup/mpei]
TUR314 M.YAKAN [Sup/mpei]
TUR314 M.YAKAN [Paiku]
TUR314 M.YAKAN [Kank Sho]
AUT193 C.ERLENWEIN [Kank]
SLO217 K.PLAZAR [Gankaku]
SLO217 K.PLAZAR [Unsu]
ITA322 M.BUSATO [Gankaku]
ITA322 M.BUSATO [Unsu]
GRE242 P.KLEVAR [Chat Kus]

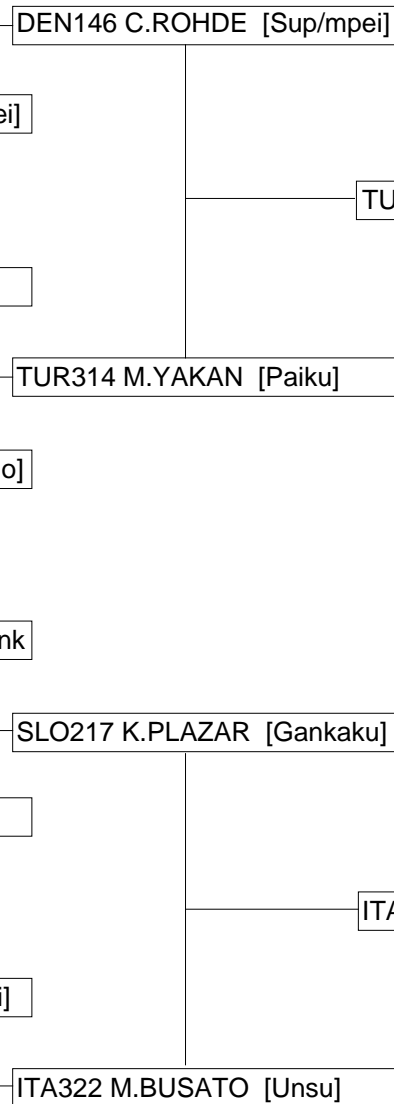

Pool 1

TATAMI



TATAMI

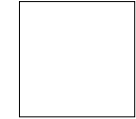

Pool 2

Under 21 Kata Male



40th EKF Junior&Cadet Karate Champ. 5th Under 21

TURKEY - Konya

8/2/2013 - 10/2/2013

Under 21 Kata Male

Repechage Pool 1

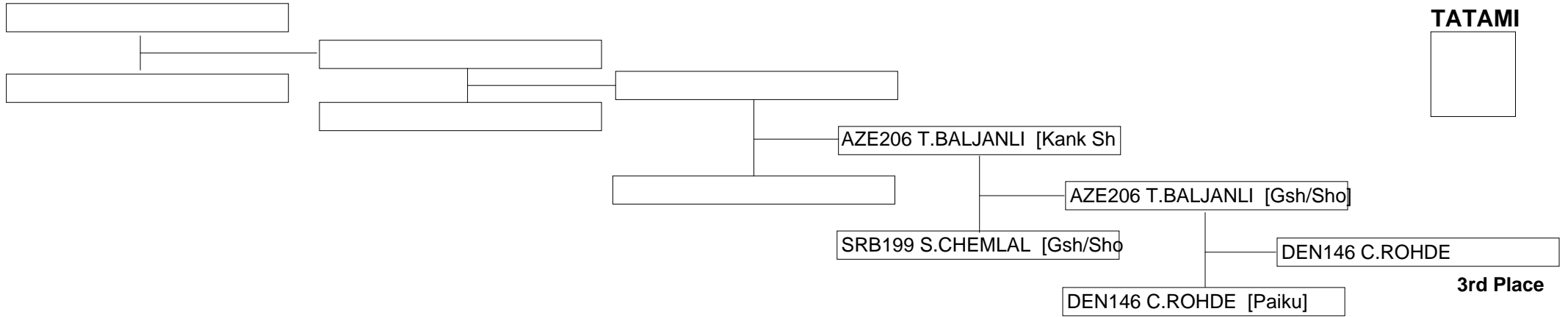

Repechage Pool 2

